

Mbetje të mureve të kështjellës së epërme

Kanali i ujit

WC

Pjesë përcjellëse e trafostacionit

Pjesë gjeneratori

Trafoja elektrike-ende në funksion

Kanali i ujit

Ura

Dera hyrëse në oborrin e Muzeut

±0.0

-2.22

-3.30

-4.48

-4.59

+3.21

-5.75

-7.77

-4.42

-4.39

Detali-04

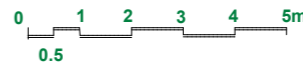

PROJEKTI I RESTAURIMIT TË HIDROELEKTRANËS SË VJETËR- PRIZRENASJA	
Investitor:	 U.S. Department of State CULTURAL PRESERVATION PROJECTS
Pjesa e projektit:	Arkitektura
Faza e projektit:	Gjendja ekzistuese
Vizatimi:	Situacioni
Përpjesa :	1 : 250
Date :	22 . 03 . 2012
Mikryqet/ Projektuesit:	project team : Jusuf XHIBO, Fikret TKVESHI, Nora Arapi-Krasniqi, Besart Dajci
Sali Shoshi Nol Binakaj Lejla Hadzic	Nr. fletës: A-001



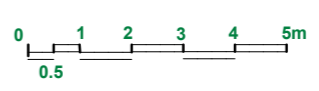
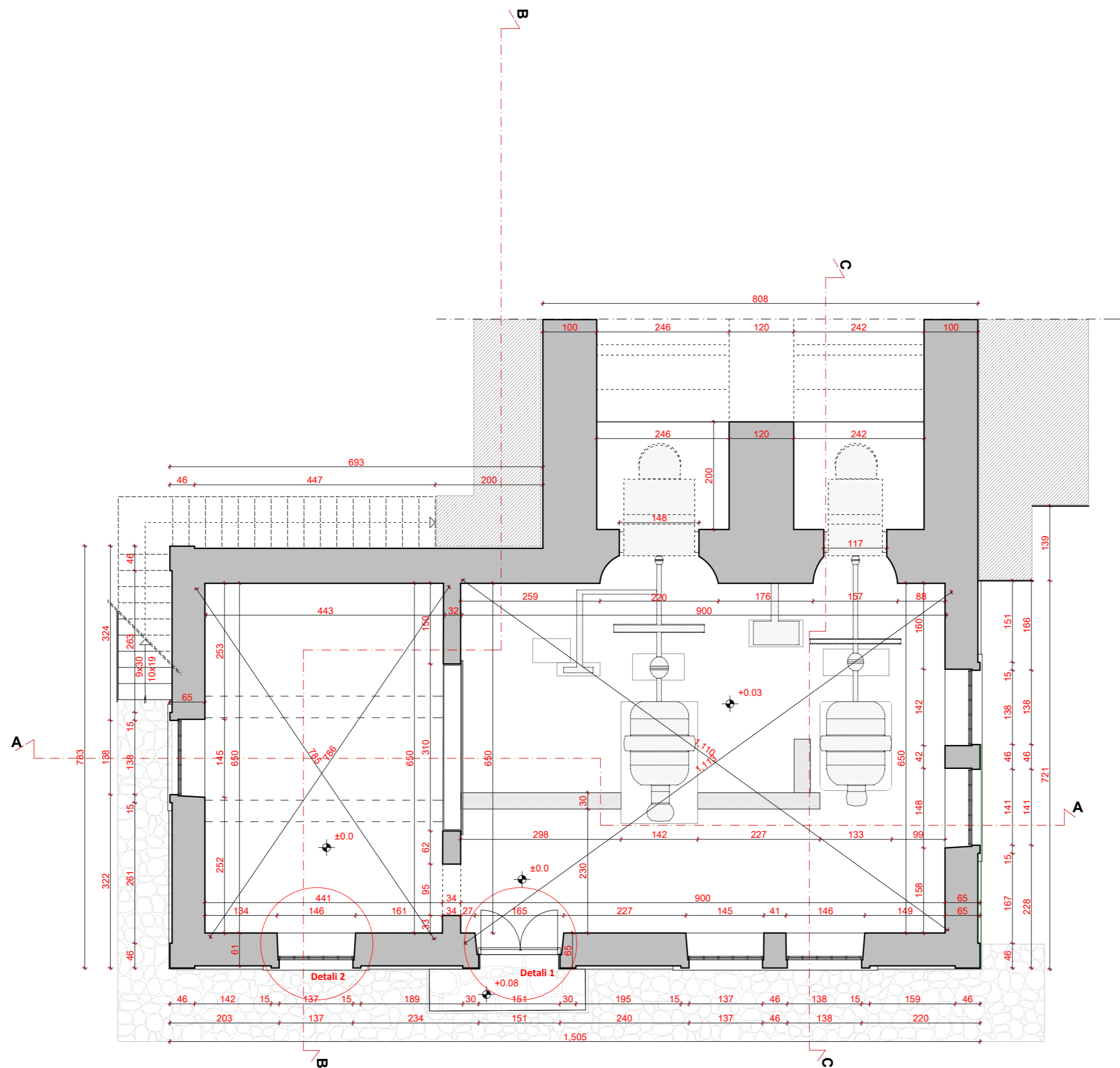
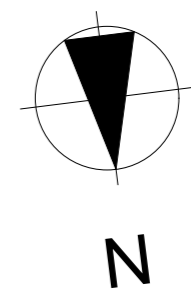

PROJEKTI I RESTAURIMIT TË HIDROELEKTRANËS SË VJETËR- PRIZRENASJA	
Investitor:	 U.S. Department of State CULTURAL PRESERVATION PROJECTS
Pjesa e projektit:	Arkitektura
Faza e projektit:	Gjendja ekzistuese
Vizatimi:	Baza e Përdheshës
Përpjesa :	1 : 50
Date :	22 . 03 . 2012
Mikrogrupi / Përkrahësit:	 Institute for the Protection of Monuments - Prizren
Projekt team : Jusuf XHIBO, Fikret TKVESH, Nora Arapi-Krasniqi, Besart Dajci	Nr. fletës: A-002
Sali Shoshi Nol Binakaj Lejla Hadzic	 CHWB Cultural Heritage without Borders KULTURNI VIZITIM QENDRISHTAR

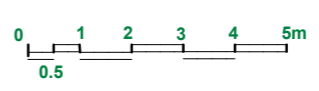
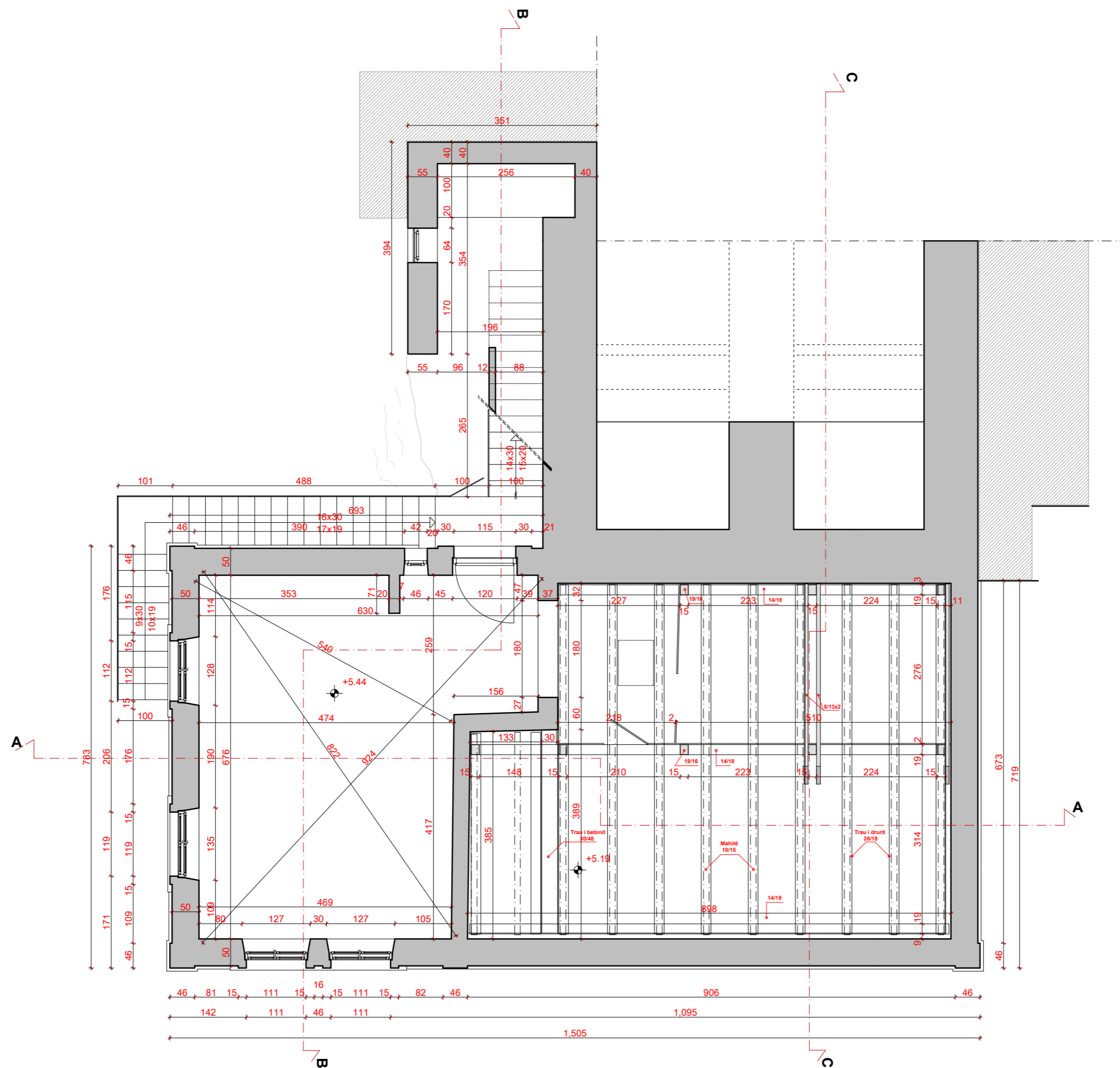
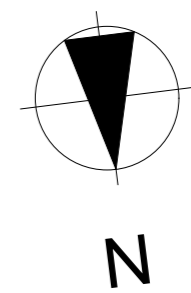

PROJEKTI I RESTAURIMIT TË HIDROELEKTRANËS SË VJETËR- PRIZRENASJA	
Investitor:	 U.S. Department of State CULTURAL PRESERVATION PROJECTS
Pjesa e projektit:	Arkitektura
Faza e projektit:	Gjendja ekzistuese
Vizatimi:	Baza e Katit
Përpjesa :	1 : 50
Date :	22 . 03 . 2012
Mikryqen/ Përgjegjës:	project team : Jusuf XHIBO, Fikret TKVESHI, Nora Arapi-Krasniqi, Besart Dajci
Nr. fletës:	A-003



**CH
WB**
Cultural
Heritage without Borders
KULTURIM VËRË GRANDE

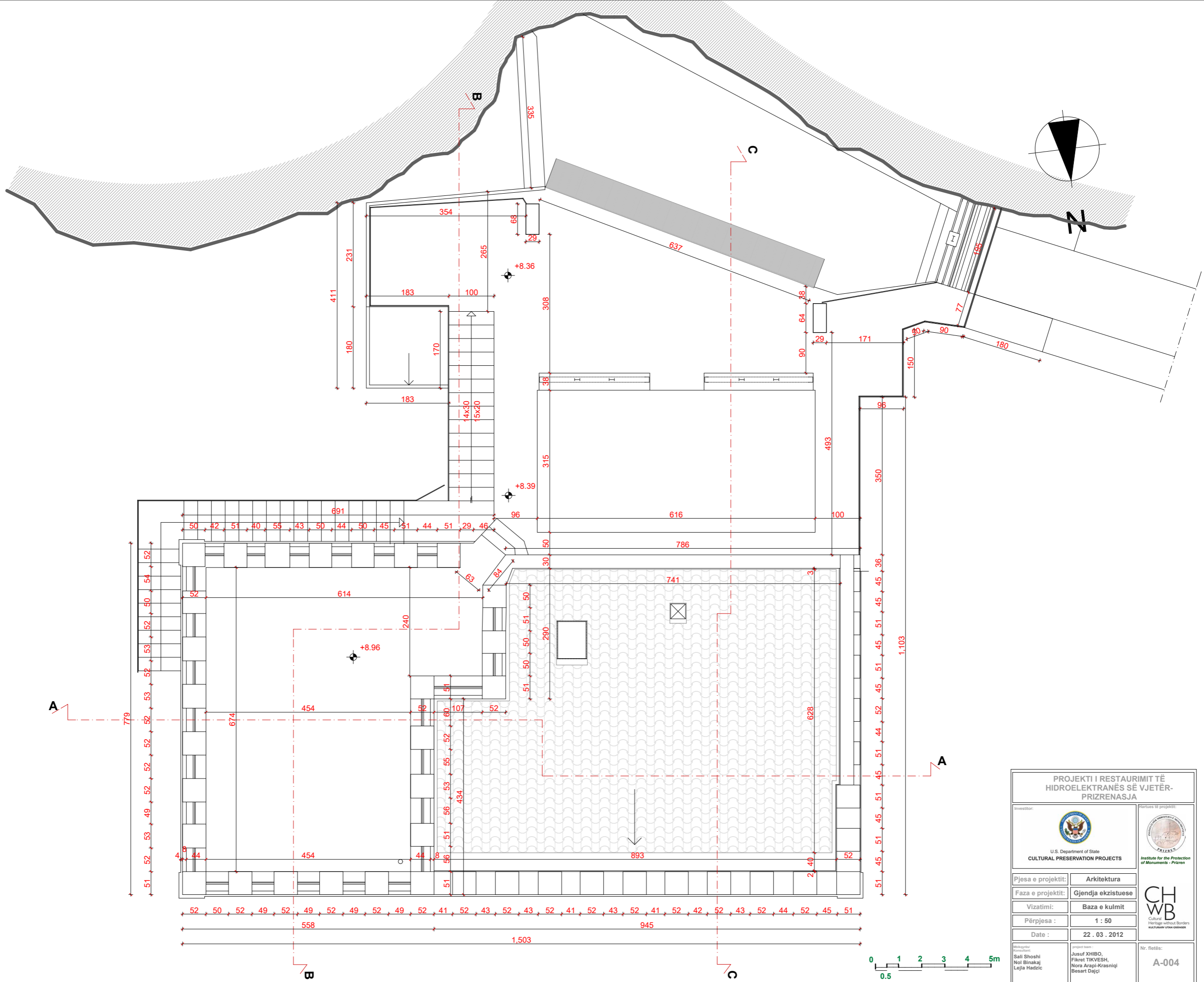

PROJEKTI I RESTAURIMIT TË HIDROELEKTRANËS SË VJETËR- PRIZRENASJA	
Investitor:	 U.S. Department of State CULTURAL PRESERVATION PROJECTS
Pjesa e projektit:	Arkitektura
Faza e projektit:	Gjendja ekzistuese
Vizatimi:	Baza e kulmit
Përpjesa :	1 : 50
Date :	22 . 03 . 2012
Mikryqytet/ Përkrahësit:	 Institute for the Protection of Monuments - Prizren
project team : Jusuf XHIBO, Fikret TKVESH, Nora Arapi-Krasniqi, Besart Dajci	Nr. fletës: A-004
Sali Shoshi Nol Binakaj Lejla Hadzic	 Cultural Heritage without Borders KULTURNYI WWW.CHWB.BE

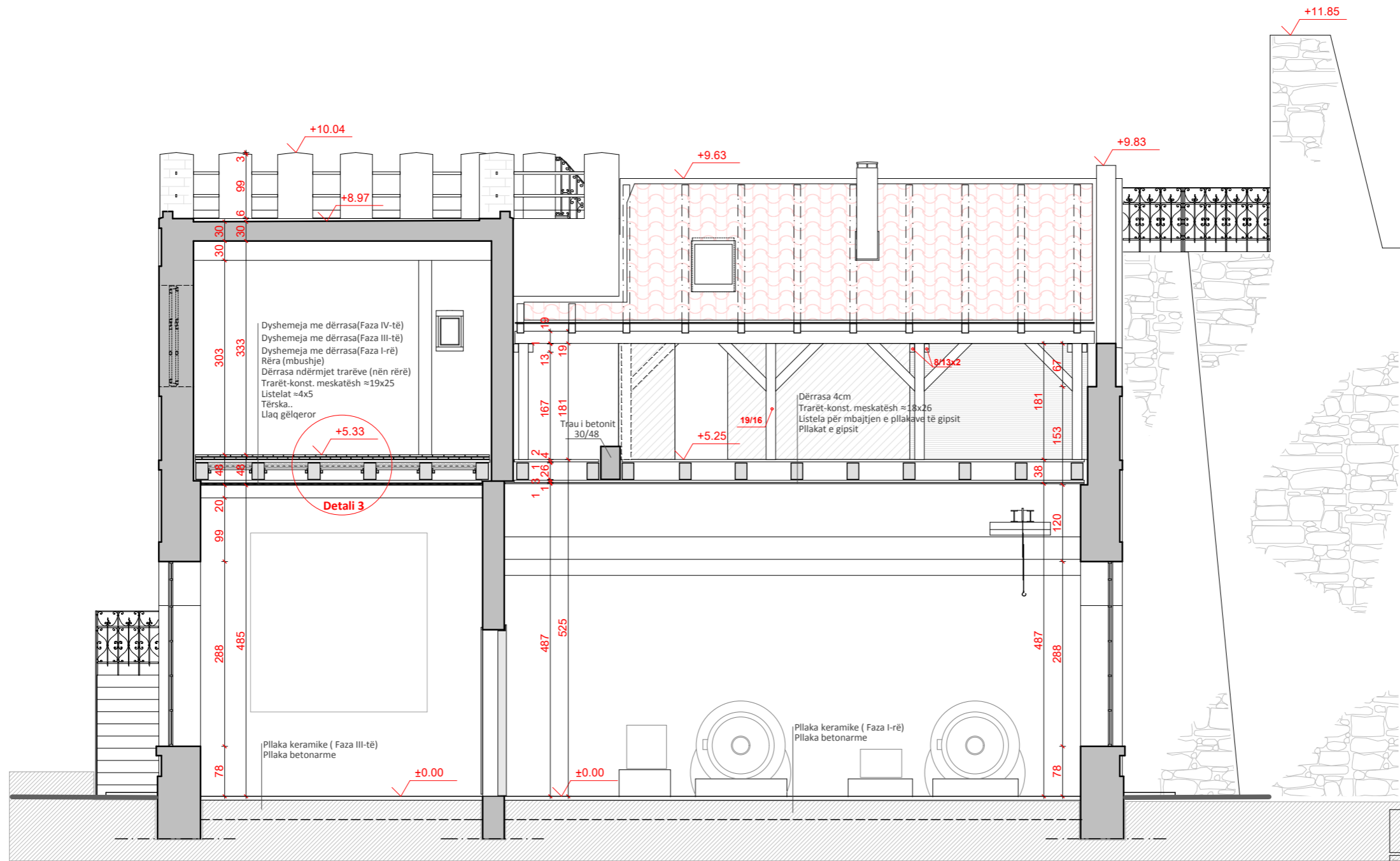

**PROJEKTI I RESTAURIMIT TË
HIDROELEKTRANËS SË VJETËR-
PRIZRENASJA**

 U.S. Department of State CULTURAL PRESERVATION PROJECTS	 Institute for the Protection of Monuments - Prizren
Pjesa e projektit: Arkitektura	Faza e projektit: Gjendja ekzistuese
Vizatimi: Prerja A-A	Përpjesa: 1 : 50
Date: 22. 03. 2012	Nr. fletës: A-005
Mikzyrtet/ Përkrahësit: Sali Shoshi Nol Binakaj Lejla Hadzic	projekt team: Jusuf XHIBO, Fikret TKVESH, Nora Arapi-Krasniqi Besart Dajci

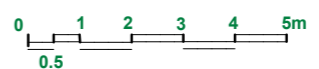

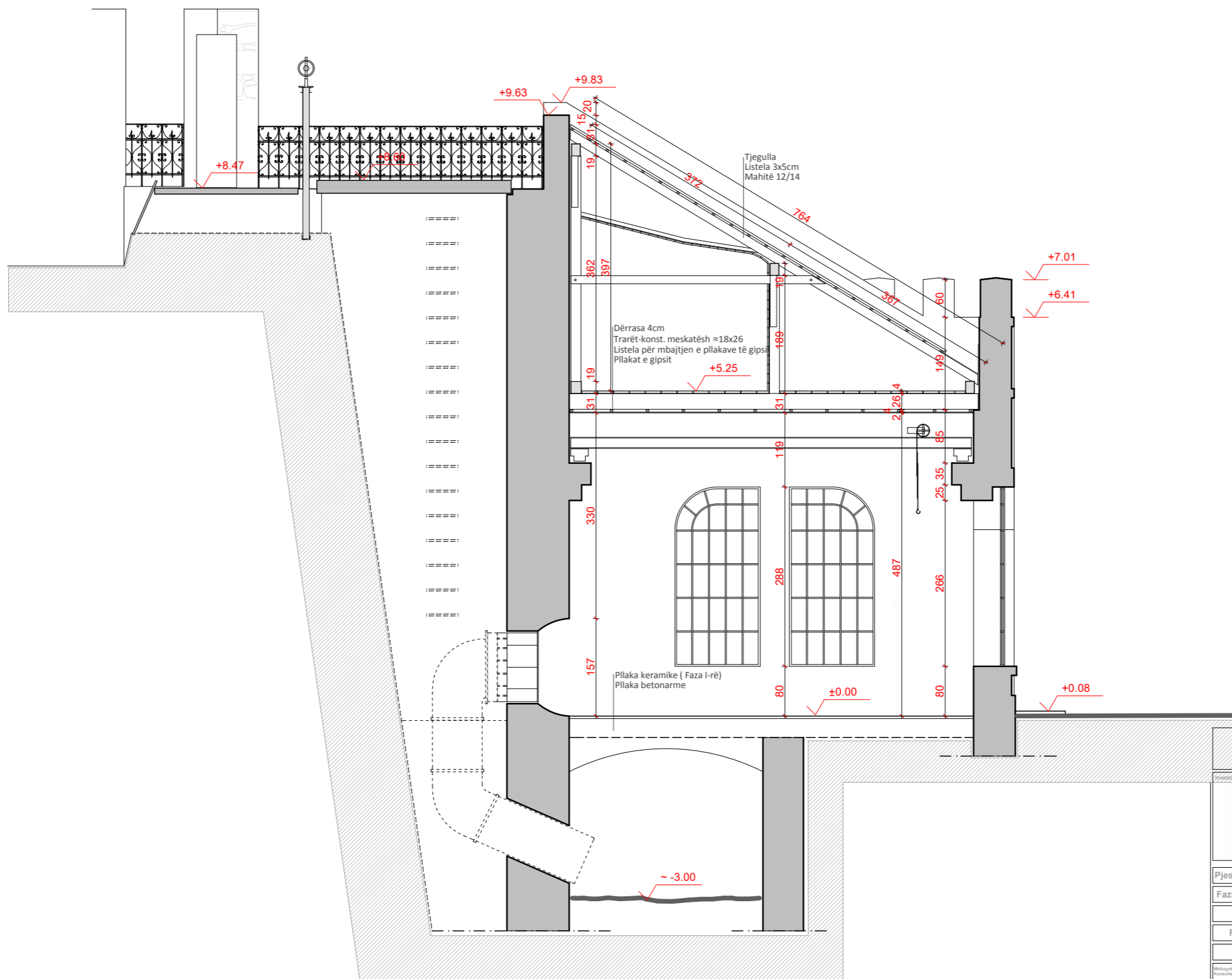

**PROJEKTI I RESTAURIMIT TË
HIDROELEKTRANËS SË VJETËR-
PRIZRENASJA**

 U.S. Department of State CULTURAL PRESERVATION PROJECTS	 Institute for the Protection of Monuments - Prizren
Pjesa e projektit:	Arkitektura
Faza e projektit:	Gjendja ekzistuese
Vizatimi:	Prerja C-C
Përpjesa :	1 : 50
Date :	22 . 03 . 2012
Mikryerët/ Përkrahës:	projekt team :
Sali Shoshi Nol Binakaj Lejla Hadzic	Jusuf XHIBO, Fikret TKVESH, Nora Arapi-Krasniqi Besart Dajci
Nr. fletës:	
A-007	

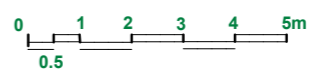

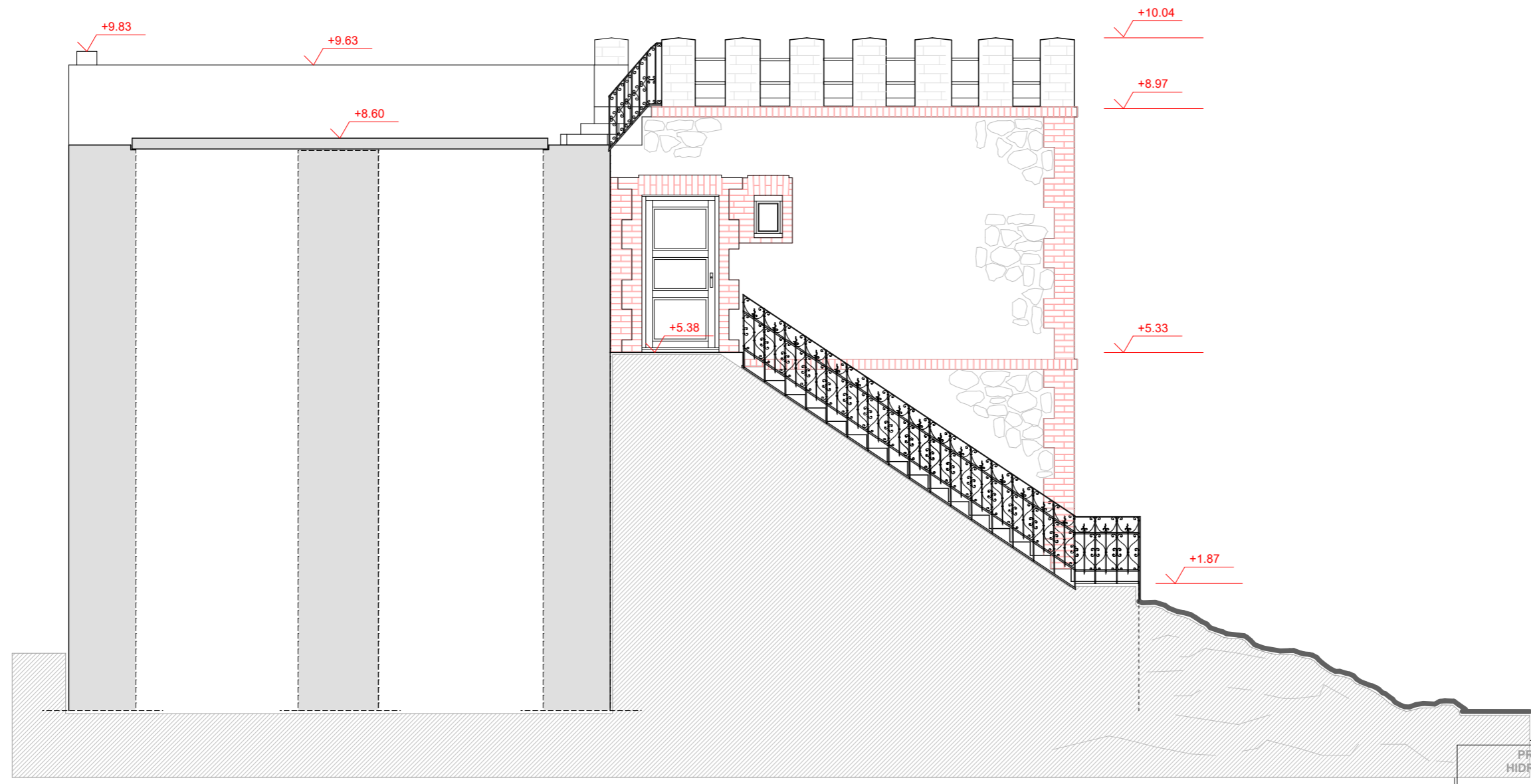

**PROJEKTI I RESTAURIMIT TË
HIDROELEKTRANËS SË VJETËR-
PRIZRENASJA**

 U.S. Department of State CULTURAL PRESERVATION PROJECTS	 Institute for the Protection of Monuments - Prizren	
Pjesa e projektit:	Arkitektura	
Faza e projektit:	Gjendja ekzistuese	
Vizatimi:	Fasada Jugore	
Përpjesa :	1 : 50	
Date :	22 . 03 . 2012	
Mikëpritës/ Financues:	projekt team :	
Sali Shoshi Nol Binakaj Lejla Hadzic	Jusuf XHIBO, Fikret TKVESH, Nora Arapi-Krasniqi Besart Dajci	
		Nr. fletës: A-008

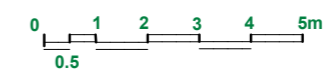

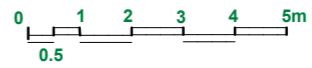
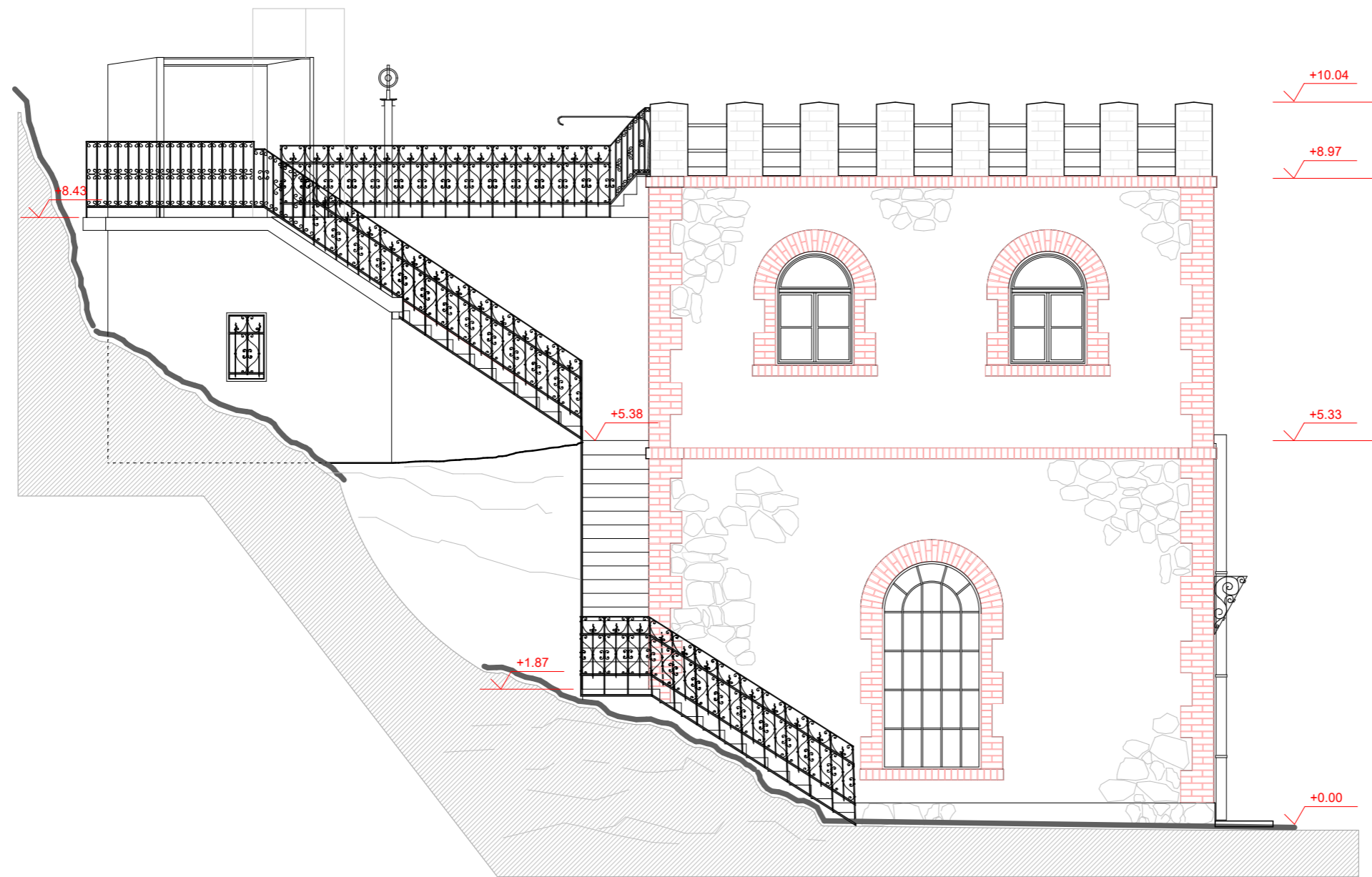

PROJEKTI I RESTAURIMIT TË HIDROELEKTRANËS SË VJETËR- PRIZRENASJA	
Investitor:	 U.S. Department of State CULTURAL PRESERVATION PROJECTS
	 Institute for the Protection of Monuments - Prizren
Pjesa e projektit:	Arkitektura
Faza e projektit:	Gjendja ekzistuese
Vizatimi:	Fasada Lindore
Përpjesa :	1 : 50
Date :	22 . 03 . 2012
Mikëpritës/ Financues:	project team : Jusuf XHIBO, Fikret TKVESH, Nora Arapi-Krasniqi Besart Dajci
Sali Shoshi Nol Binakaj Lejla Hadzic	Nr. fletës: A-009

**CH
WB**
Cultural
Heritage without Borders
KULTURNI VIZITIM QENDROR



**PROJEKTI I RESTAURIMIT TË
HIDROELEKTRANËS SË VJETËR-
PRIZRENASJA**

 U.S. Department of State CULTURAL PRESERVATION PROJECTS		 Institute for the Protection of Monuments - Prizren	
Pjesa e projektit:	Arkitektura	 CHWB Cultural Heritage without Borders <small>KULTURNI VIZITIM QASIMOR</small>	
Faza e projektit:	Gjendja ekzistuese		
Vizatimi:	Fasada Veriore		
Përpjesja :	1 : 50		
Date :	22 . 03 . 2012		
Mikëpritës/ Financues:	projekt team :	Nr. fletës:	
Sali Shoshi Nol Binakaj Lejla Hadzic	Jusuf XHIBO, Fikret TKVESH, Nora Arapi-Krasniqi Besart Dajci	A-010	

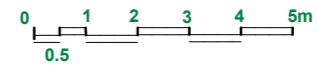

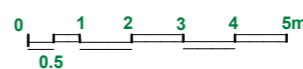
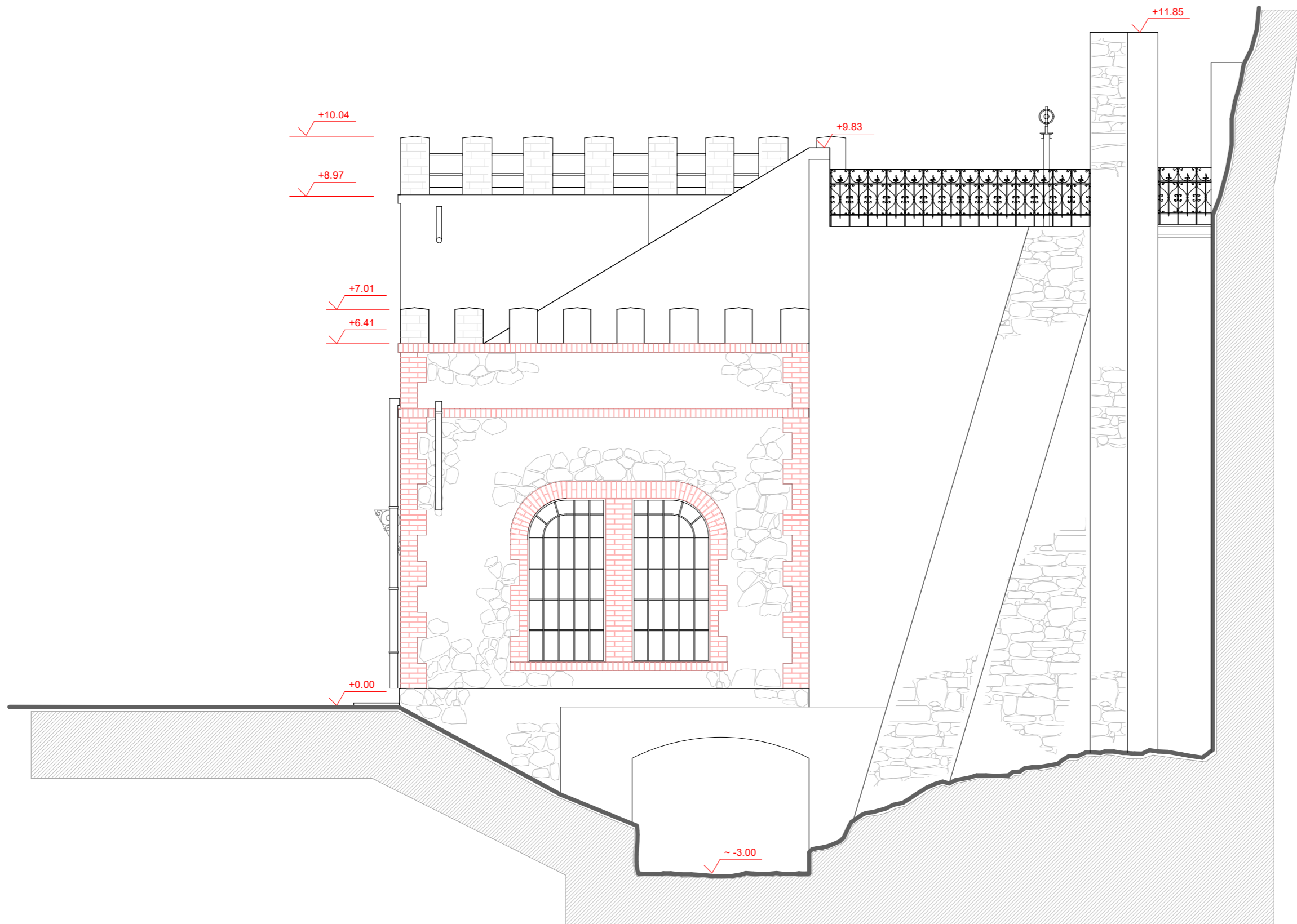

PROJEKTI I RESTAURIMIT TË HIDROELEKTRANËS SË VJETËR- PRIZRENASJA	
Investitor:	 U.S. Department of State CULTURAL PRESERVATION PROJECTS
	 Institute for the Protection of Monuments - Prizren
Pjesa e projektit:	Arkitektura
Faza e projektit:	Gjendja ekzistuese
Vizatimi:	Fasada Perëndimore
Përpjesja :	1 : 50
Date :	22 . 03 . 2012
Mikëqytet/ Pronuesit:	project team : Jusuf XHIBO, Fikret TKVESH, Nora Arapi-Krasniqi Besart Dajci
Sali Shoshi Nol Binakaj Lejla Hadzic	Nr. fletës: A-011

**CH
WB**
Cultural
Heritage without Borders
KULTURNI VIZITIM

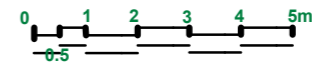
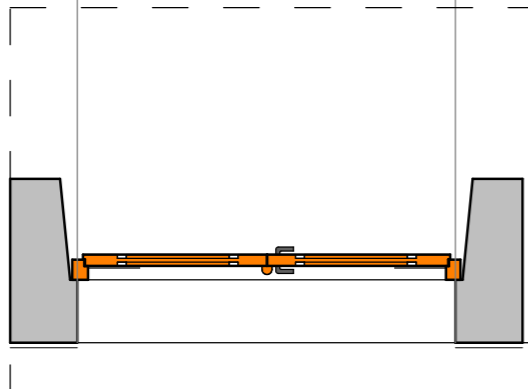
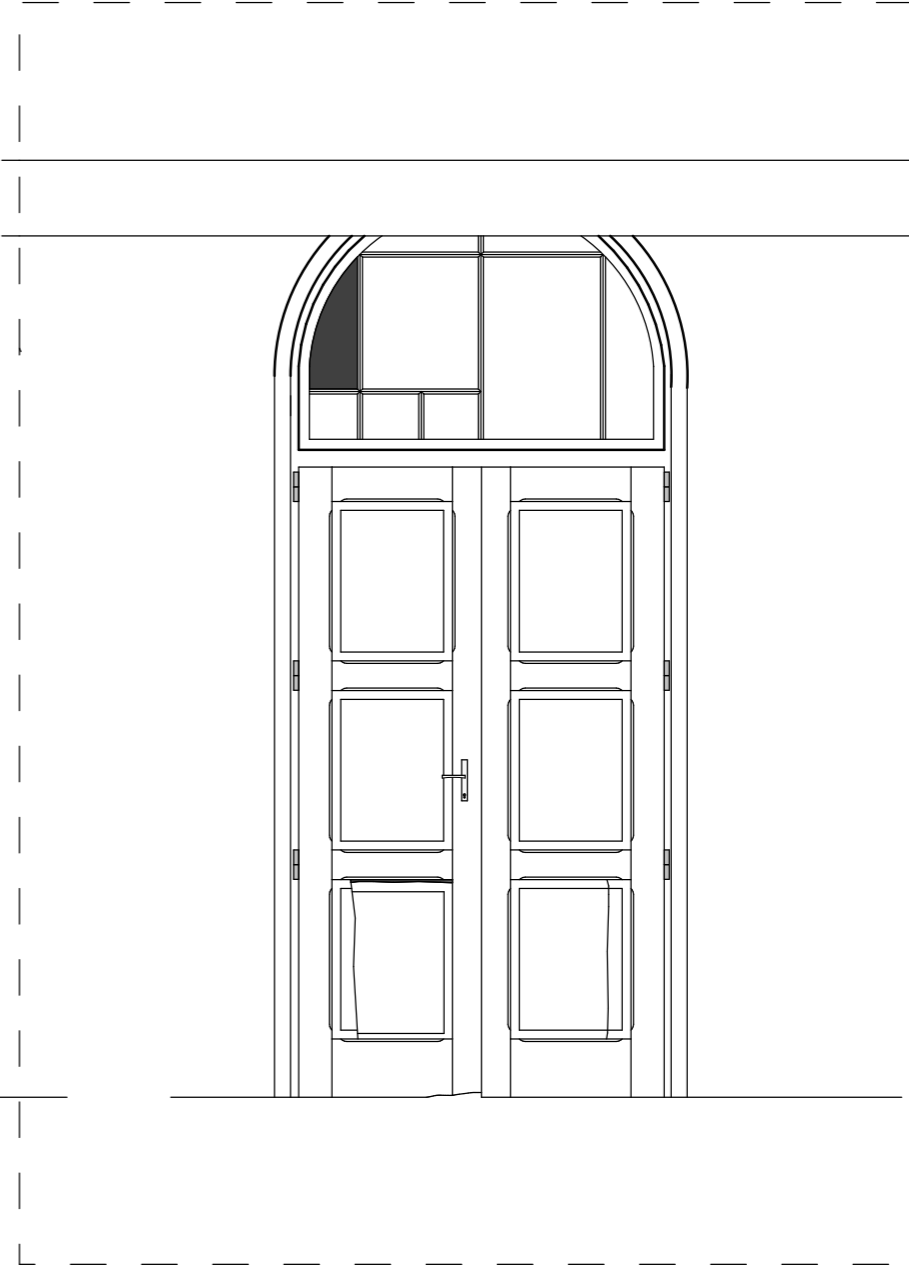
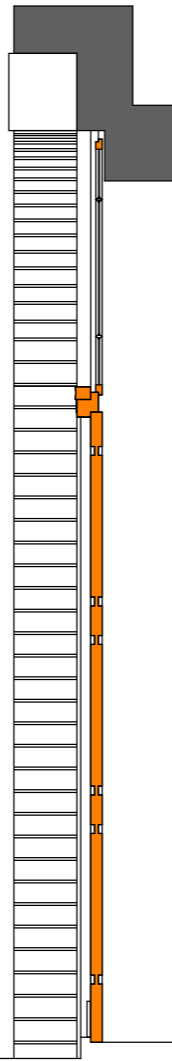
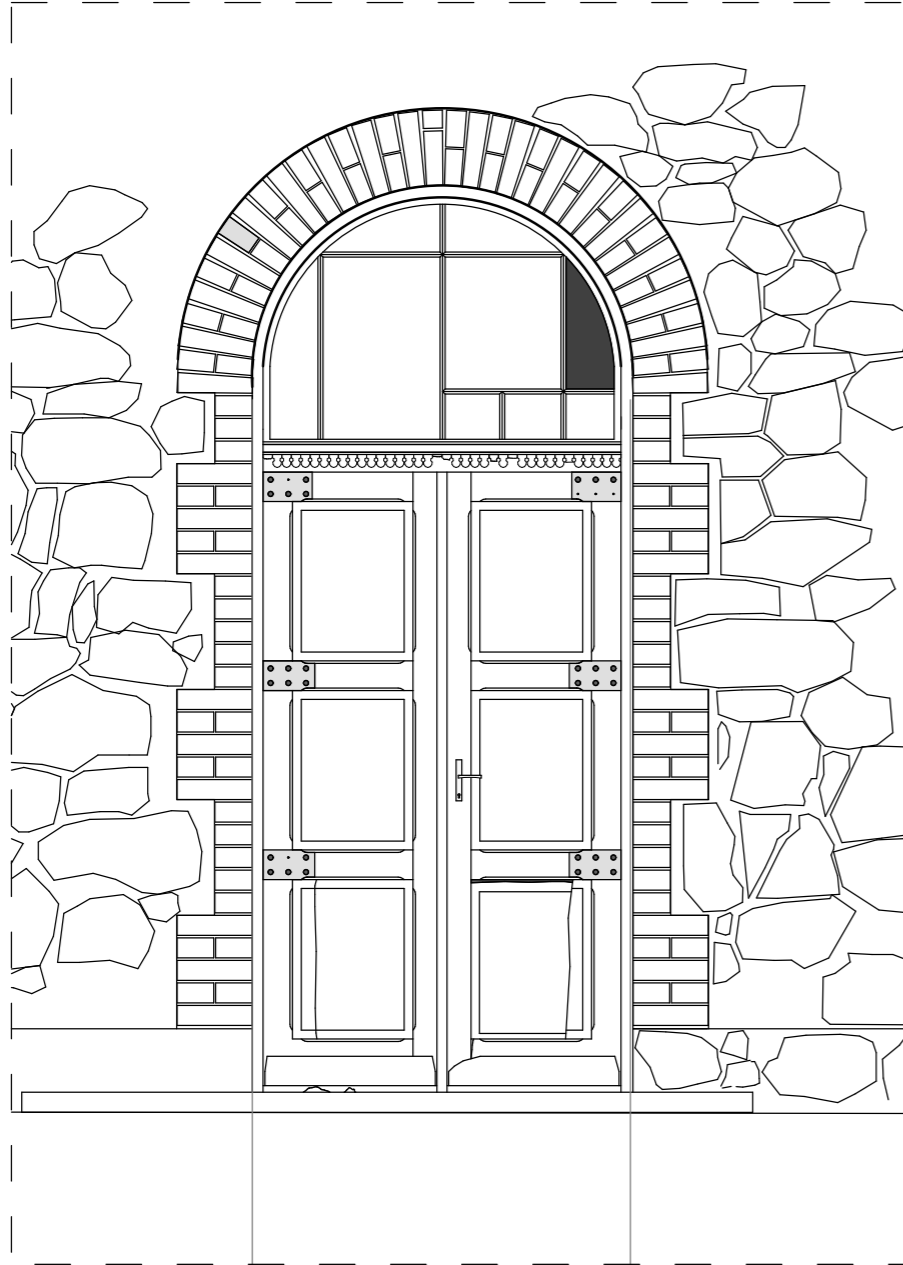

PROJEKTI I RESTAURIMIT TË HIDROELEKTRANËS SË VJETËR- PRIZRENASJA	
Investitor:	 U.S. Department of State CULTURAL PRESERVATION PROJECTS
Pjesa e projektit:	Arkitektura
Faza e projektit:	Gjendja ekzistuese
Vizatimi:	Detali 1-Dera kryesore
Përpjesa :	1 : 30
Date :	22 . 03 . 2012
Mikryesur/ Përkrahës:	 Institute for the Protection of Monuments - Prizren
projekt team : Sali Shoshi Nol Binakaj Lejla Hadzic	Nr. fletës: A-029

**CH
WB**
Cultural
Heritage without Borders
KULTURNI VIZITIM

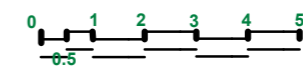
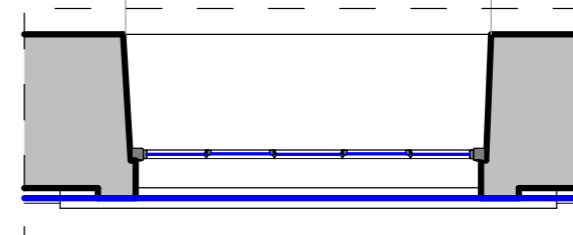
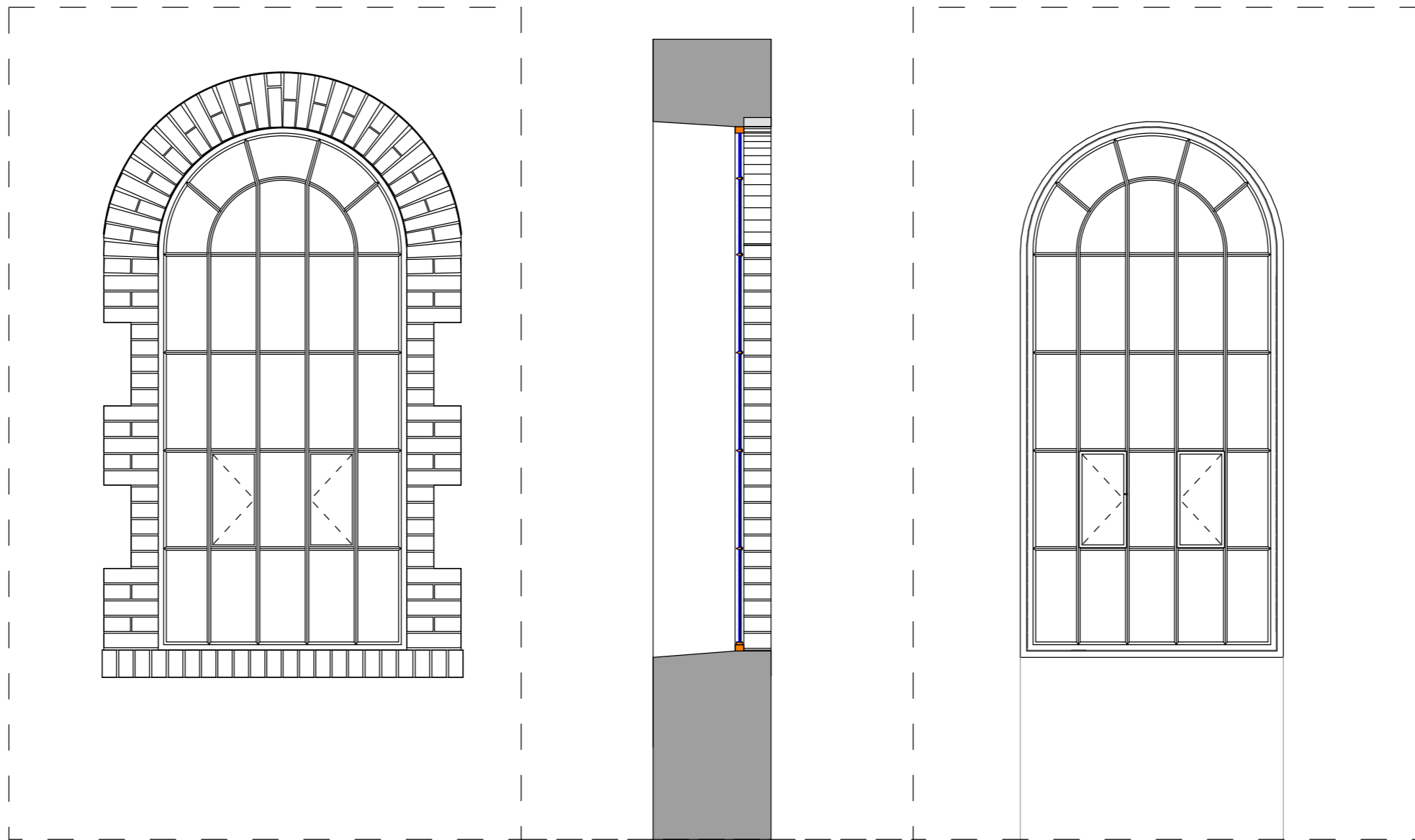

PROJEKTI I RESTAURIMIT TË HIDROELEKTRANËS SË VJETËR- PRIZRENASJA	
Investitor:	 U.S. Department of State CULTURAL PRESERVATION PROJECTS
Pjesa e projektit:	Arkitektura
Faza e projektit:	Gjendja ekzistuese
Vizatimi:	Detali 2- Dritarja
Përpjesa :	1 : 50
Date :	22 . 03 . 2012
Mikrypues/ Përkrahues:	 Institute for the Protection of Monuments - Prizren
projekt team : Jusuf XHIBO, Fikret TKVES, Nora Arapi-Krasniqi Besart Dajci	Nr. fletës: A-030
Sali Shoshi Nol Binakaj Lejla Hadzic	 CH WB Cultural Heritage without Borders KULTURNI VIZITIM QENDRISHTAR

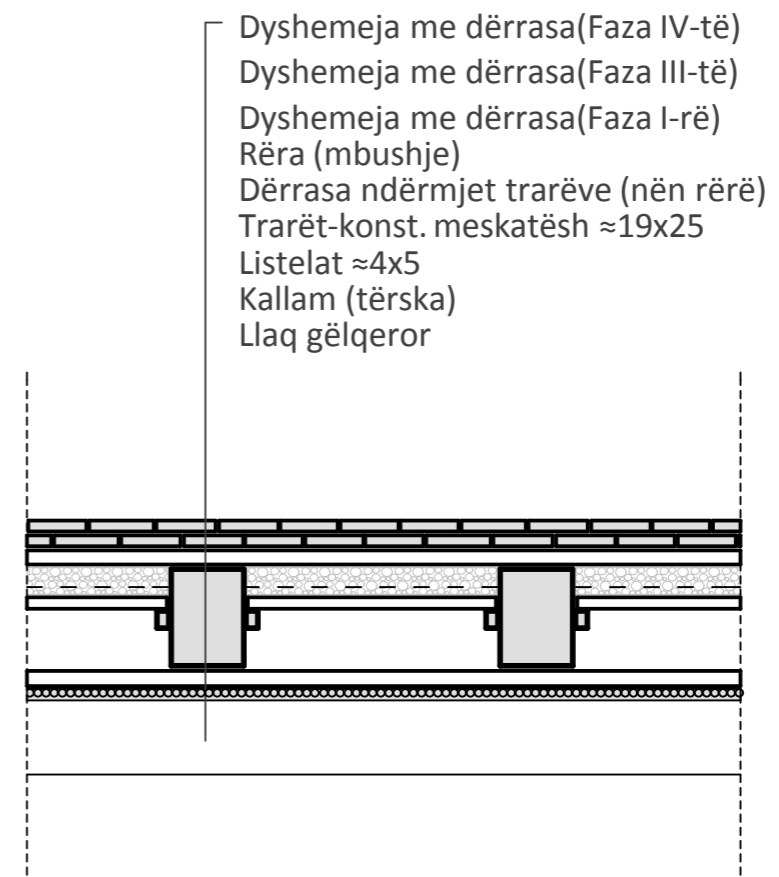
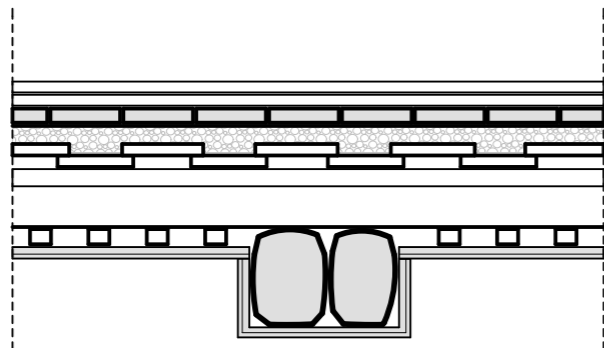

- Dyshemeja me dërrasa(Faza IV-të)
- Dyshemeja me dërrasa(Faza III-të)
- Dyshemeja me dërrasa(Faza I-rë)
- Rëra (mbushje)
- Dërrasa ndërmjet trarëve (nën rërë)
- Trarët-konst. meskatësh ≈19x25
- Listelat ≈4x5
- Kallam (tërska)
- Llaq gëlqeror

Detali 3



PROJEKTI I RESTAURIMIT TË HIDROELEKTRANËS SË VJETËR- PRIZRENASJA	
Investitor:	 U.S. Department of State CULTURAL PRESERVATION PROJECTS
	 Institute for the Protection of Monuments - Prizren
Pjesa e projektit:	Arkitektura
Faza e projektit:	Gjendja ekzistuese
Vizatimi:	Detali 3-Dyshemeja ne kat
Përpjesa :	1 : 20
Date :	22 . 03 . 2012
Mikëpritës/ Financues:	project team : Jusuf XHIBO, Fikret TKVES, Nora Arapi-Krasniqi Besart Dajci
	Nr. fletës: A-031

**CH
WB**
Cultural
Heritage without Borders
KULTURNI VIZITIM QË SHKËMBËN

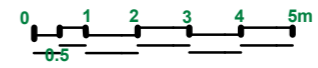
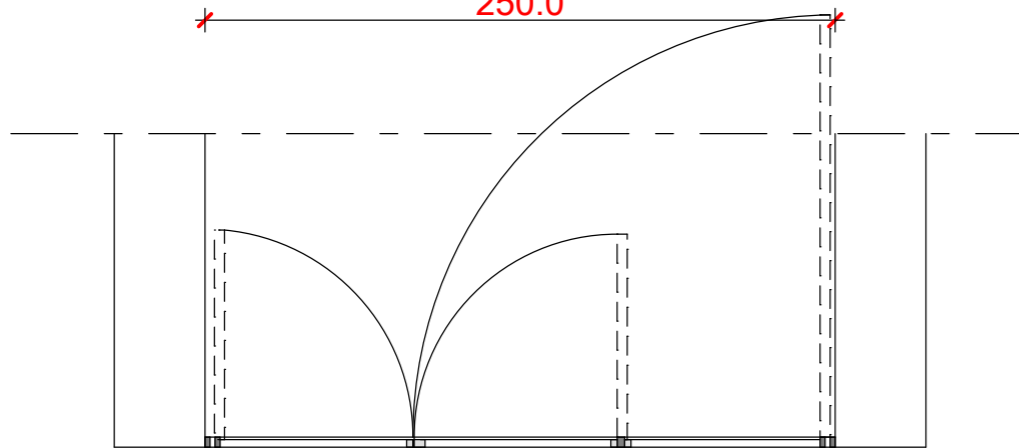
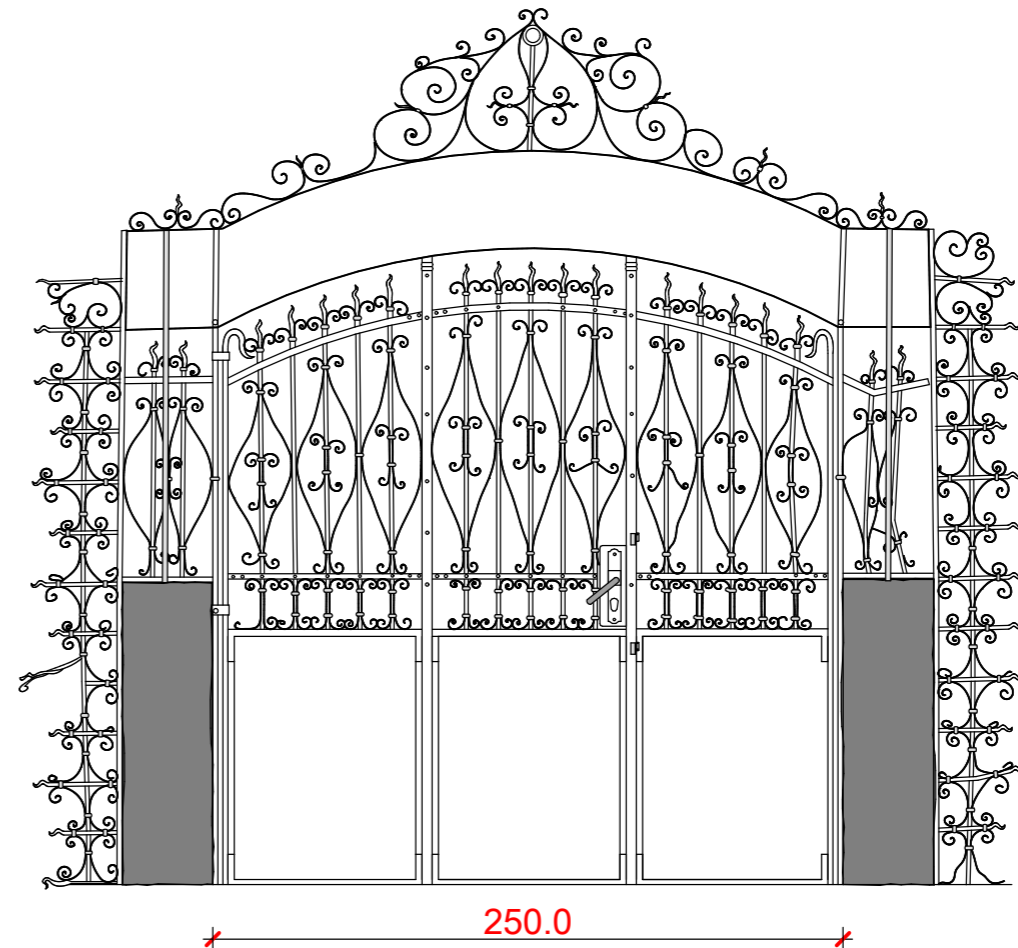
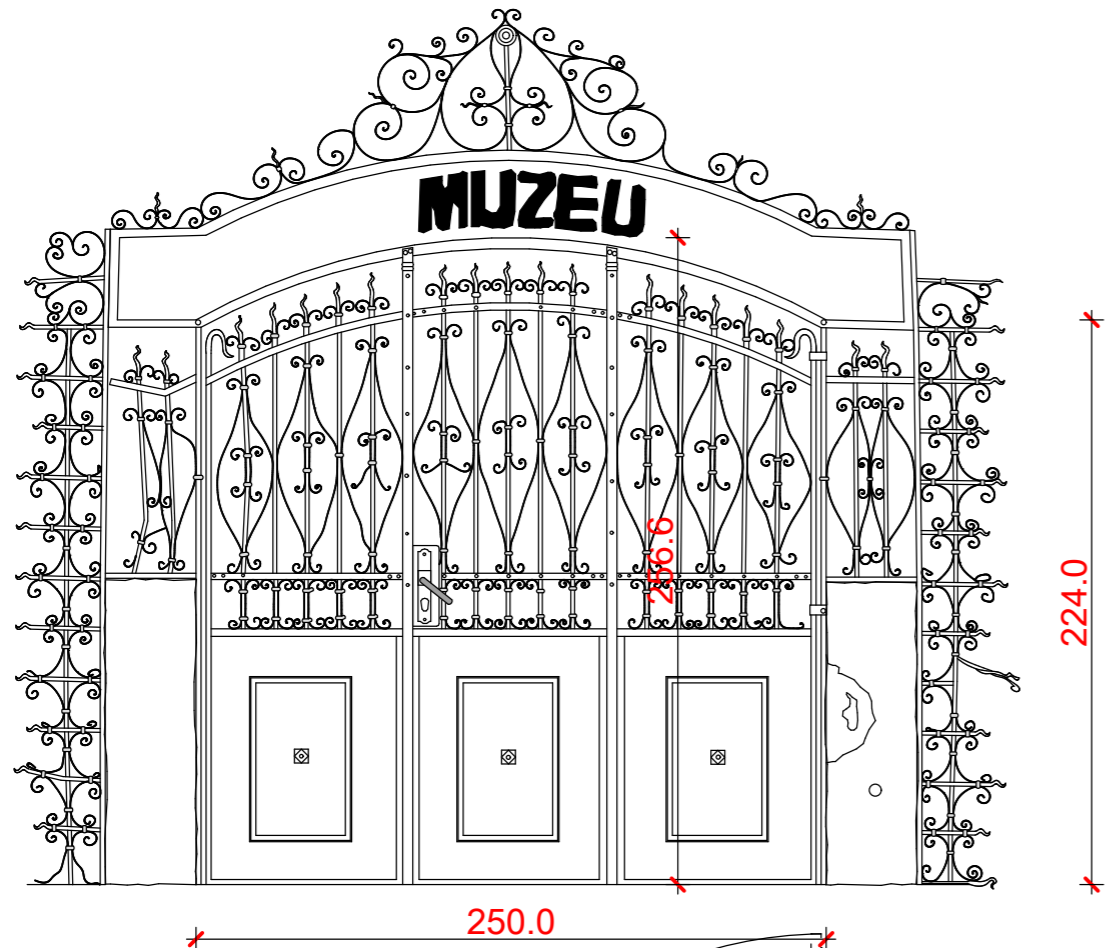

PROJEKTI I RESTAURIMIT TË HIDROELEKTRANËS SË VJETËR- PRIZRENASJA			
Investitor:		Instituti i Prizrenit	
 U.S. Department of State CULTURAL PRESERVATION PROJECTS		 Institute for the Protection of Monuments - Prizren	
Pjesa e projektit:	Arkitektura	 CHWB Cultural Heritage without Borders <small>KULTURNI VIZITIM QASIMOR</small>	
Faza e projektit:	Gjendja ekzistuese		
Vizatimi:	Detali 4-Dera e hyrjes ne oborr		
Përpjesa :	1 : 30		
Date :	22 . 03 . 2012		
Mikrografi/ Pronuesit:	Projekt team :	Nr. fletës:	
Sali Shoshi Nol Binakaj Lejla Hadzic	Jusuf XHIBO, Fikret TKVES, Nora Arapi-Krasniqi Besart Dajci	A-032	